

HERO B

108798.21H

novalux
ITALIAN LIGHTING DESIGN SINCE 1948

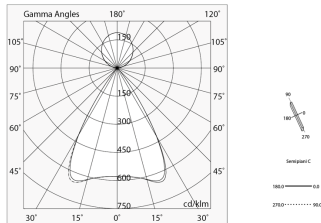
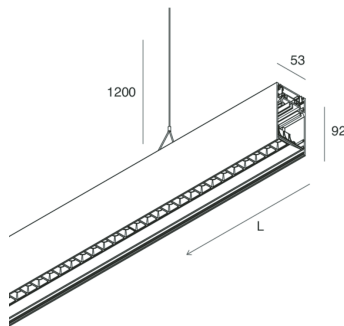
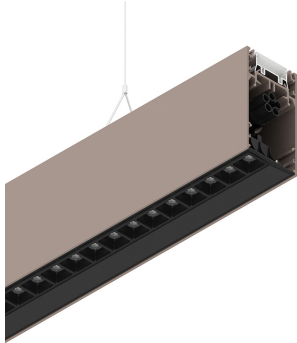

Features

Use: Indoor
Type of installation: SUSPENDED
Emission: DIRECT/INDIRECT
Optics: MICRO OPTICS
Colour: CAPPUCCINO
Dimming: PUSH
Emergency: NO
L: 1428mm
A: 53mm
H: 92mm
Made in: ITALY
Warranty: 5 years
Weight: 5kg

Tech data

Luminaire input power: 69W
Luminaire luminous flux: 6468lm
Direct luminous flux: 3638lm
Indirect luminous flux: 2830lm
IP: 40
Insulation class: I
Supply voltage: 220-240V 50/60Hz
UGR: <19
SELV: Si

Source

Light source: LED
Source power: 61W
Colour temperature: 3000K
CRI: >90
Colour tolerance: 3 Step MacAdam
LED lifespan: 50000h L80 B20

Compliance

CEI EN 60598-1:2021 + A11:2023, CEI EN 60598-2-1:2022

Standards

Photobiological risk: RISK GROUP 0 Certified fixture in EXEMPT GROUP, in accordance with CEI EN 62471:2010-01, IEC TR 62778:2014.
CAM edilizia: The product complies with the requirements for public buildings, ministerial decree of 23rd June 2022 n.256.

[View more product info](#)



Novalux S.r.l. via Marzabotto, 2 40050 Funo di Argelato (BO) Italy
Tel: +39 051 860558 · Fax +39 051 6647859 · Mail: info@novalux.it · VAT number 00536541204 · novalux.com
Company subject to the management and coordination by SLV GmbH

This technical data sheet is owned by Novalux S.r.l., all rights reserved. Novalux S.r.l. reserves the right to make changes without prior notice.
Last update: 26/2/2024, 10:03:54