



## Caratteristiche

Uso: Interno

Tipo installazione: PARETE, INCASSO IN CARTONGESSO, SOSPENSIONE, PLAFONE, BINARIO

Colore: NERO

Dimmerazione: DALI2

L: 280mm

A: 53mm

H: 69mm

Made in: ITALY

Garanzia: 5 anni

Peso: 1.5kg

## Dati tecnici

IP: 40

Classe di isolamento: I

SELV: No

[HERO PLUS: Visualizza maggiori info sul prodotto](#)

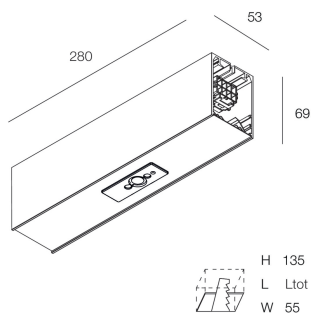







# HERO PLUS

114691.02

**novalux**  
ITALIAN LIGHTING DESIGN SINCE 1948

## ACCESSORI DI COMPLETAMENTO

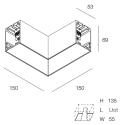
	HERO+: KIT DI GIUNZIONE PROFILI 1PZ	<b>108940.99</b>
	HERO: COPPIA TESTATE NE	<b>108684.02</b>
	HERO+: MOD.CIECO 280 NE	<b>114685.02</b>
	HERO+: MOD.CIECO 1120 NE	<b>114686.02</b>
	HERO+: MOD.CIECO 1400 NE	<b>114687.02</b>
	HERO+: MOD.CIECO 1680 NE	<b>114688.02</b>
	HERO+: MOD.CIECO ANG. SX DX 150 NE	<b>114689.02</b>

## ACCESSORI DI MONTAGGIO

	HERO: SOSPL.3000 1PZ TESTA W.G.ALTO	<b>1086A1.99</b>
	HERO+: SOSP L.3M REGOLA. DAL BASSO 1PZ	<b>114694.99</b>
	HERO: KIT INCASSO LED (1X)	<b>108688.99</b>



Novalux S.r.l. via Marzabotto, 2 40050 Funo di Argelato (BO) Italy  
Tel: +39 051 860558 · Fax +39 051 6647859 · Mail: info@novalux.it · P.IVA 00536541204 · novalux.com  
Società soggetta ad attività di direzione e coordinamento da parte di SLV GmbH

La presente scheda tecnica è di proprietà di Novalux S.r.l., tutti i diritti riservati. Novalux S.r.l. si riserva il diritto di apportare modifiche senza preavviso alcuno.  
Ultimo aggiornamento: 9/6/2026, 14:06:11

# HERO PLUS

114691.02

**novalux**  
ITALIAN LIGHTING DESIGN SINCE 1948



HERO: SPESS. CARTONG. 10MM 2PZ.

**108689.99**



KIT ALIMENTAZIONE L3000 5P BIA

**108922.01**



KIT ALIMENTAZIONE L3000 5P NE

**108922.02**



KIT ALIMENTAZIONE L3000 5P CAF

**108922.20**



KIT ALIMENTAZIONE L3000 5P CAP

**108922.21**

## ACCESSORI DI EMERGENZA



HERO+: KIT 2 CAVI 1X1.5 EMERGE. L.1400

**108941.99**



Novalux S.r.l. via Marzabotto, 2 40050 Funo di Argelato (BO) Italy  
Tel: +39 051 860558 · Fax +39 051 6647859 · Mail: info@novalux.it · P.IVA 00536541204 · novalux.com  
Società soggetta ad attività di direzione e coordinamento da parte di SLV GmbH

La presente scheda tecnica è di proprietà di Novalux S.r.l., tutti i diritti riservati. Novalux S.r.l. si riserva il diritto di apportare modifiche senza preavviso alcuno.  
Ultimo aggiornamento: 9/6/2026, 14:06:11